

Butterfly® Rail Truss

Indirect Truss Mounted LED 120-277VAC IP66

Project

Date



LENGTHS (NOM.)

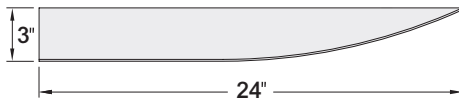
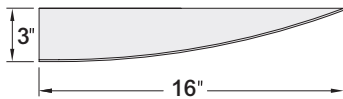

STANDARD

Forward Throw

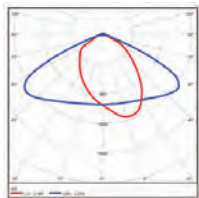

OPTIONAL

Wide Forward Throw

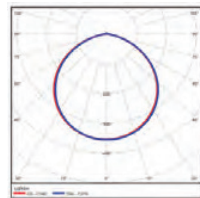

CCT	30K, 35K, 40K, 50K								
Length	16"						24"		
LED Output	L25	L50	L75	L90	L120	L150	L200	L270	L340
Wattage	25W	50W	75W	90W	120W	150W	200W	270W	340W
Lumes	3,500	7,000	10,500	12,600	16,800	21,100	28,000	37,800	47,600
Weight	12 lbs						16 lbs		

DESCRIPTION

Butterfly® Rail Truss is a bold architectural wing-profile fixture designed to seamlessly integrate with Orgatech's streamlined truss mounting system. Its distinctive wing form delivers wide, even illumination while enhancing the visual rhythm of large spaces. Ideal for arenas, gymnasiums, indoor pools, natatoriums, venues, and large commercial interiors, Butterfly Rail Truss provides powerful indirect lighting within a modern, slim profile. The IP67-rated system transforms overhead structures into dramatic architectural lighting statements while delivering durable performance in demanding environments.

FEATURES

Construction	Durable Die-Cast Aluminum Housing. Stainless Steel Hardware. High impact protective lens
Dimensions	13"W x 16.75"L x 2.8"H / 13"W x 24.75"L x 5.125"H
Weight	16" - 12lbs / 24" - 16lbs
CCT	3000K, 3500K, 4000K, 5000K
Dimming	Non-dimming, 0-10V Dimming
Optics	Standard Forward Throw or Optional Wide Forward Throw Rotatable Lenses (Every 90°)
Mounting	Pendant Truss Mount
Finish	Epoxy Powder Coated Silver, White, Black, Bronze, Custom

PERFORMANCE

Electrical	120-277V AC / 277-480V AC Input line voltage
LED Wattage	25W, 50W, 75W, 90W, 120W, 150W, 200W, 270W, 340W
Environment	IP66 - Suitable for Wet Locations. Natatorium - Marine Grade Finish Operating Temperature - 40°F to 122°F
Warranty	5 yr/ 50,000 hour limited warranty
CRI	80+
Certifications	UL Listed

ORDERING GUIDE Make selections by filling out the **top row** or highlighting options.

3600	Length	Output	CCT	Voltage	Control	Mounting	Finish	Accessory
3600	16 16" nom	L25 25W L50 50W L75 75W L90 90W L120 120W L150 150W	30 3000K 35 3500K 40 4000K 50 5000K	U 120-277V U2 277-480V	ND Non Dimming D1 0-10V Dimming	TM Truss Mount	WH White BL Black BZ Bronze SO Silver CU Custom	M Marine Grade Finish 2 Natatorium E Emergency Driver (remote location) W Wide Optic *SF SurgeProtector & Inline Fuse N None
	24 24" nom	L200 150W L270 150W L340 150W						

*RECOMMENDED FOR USE WITH 4000K, 3500K, 3000K, 27000K ONLY

*SF OPTION REQUIRES VOLTAGE REQUIREMENT TO NOT EXCEED 240VAC / ONLY AVAILABLE ON (U) UNIVERSAL VOLTAGE SYSTEMS

Specifications sheets are subject to change without notification.

PHOTOMETRICS

25 WATT - Forward Throw

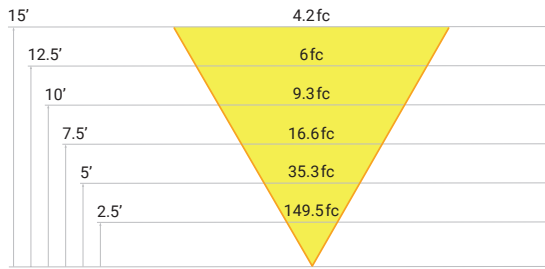

25 WATT - Wide Forward Throw

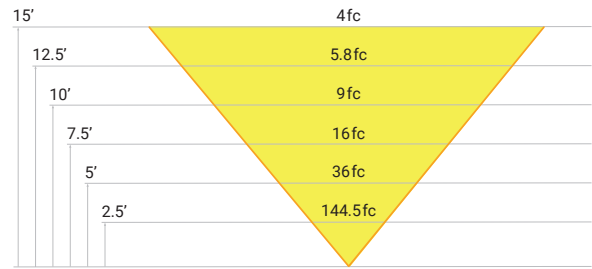

50 WATT - Forward Throw

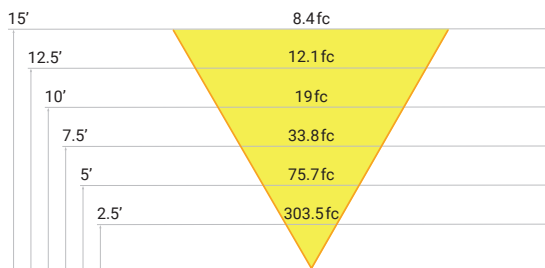

50 WATT - Wide Forward Throw

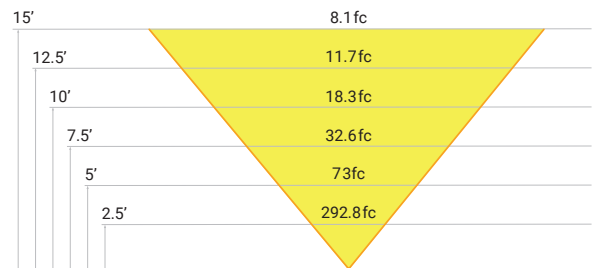

75 WATT - Forward Throw

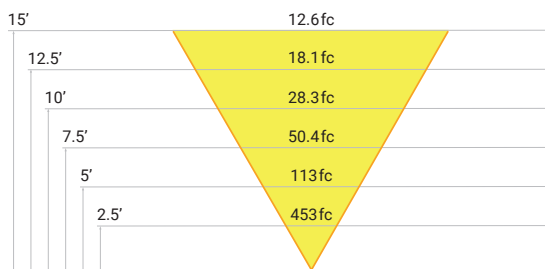

75 WATT - Wide Forward Throw

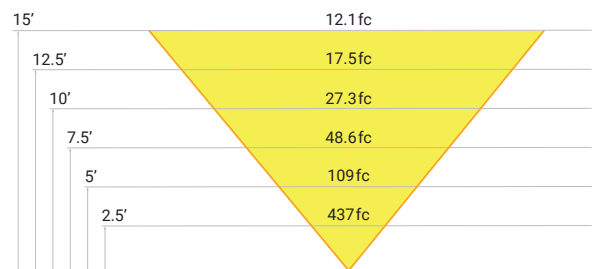

90 WATT - Forward Throw

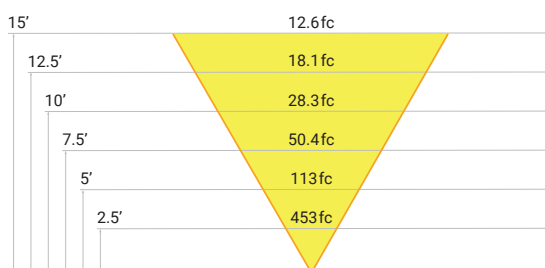

90 WATT - Wide Forward Throw

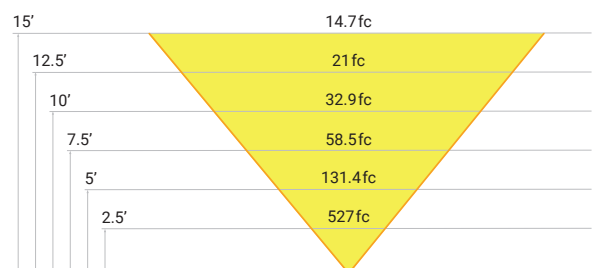

120 WATT - Forward Throw

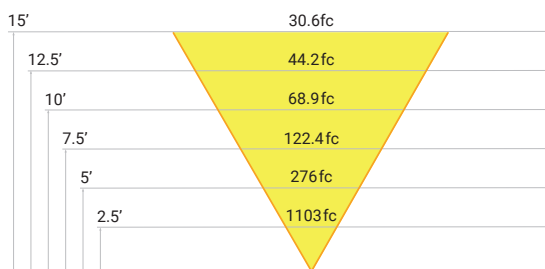

120 WATT - Wide Forward Throw

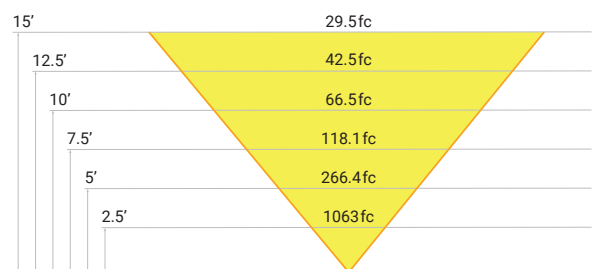

PHOTOMETRICS

150 WATT - Forward Throw

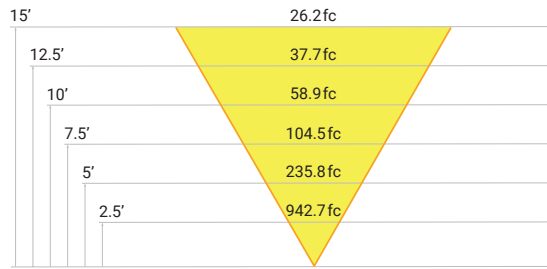

150 WATT - Wide Forward Throw

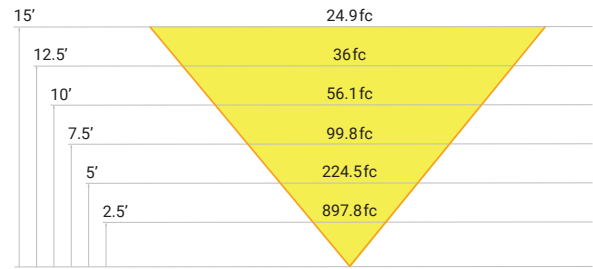

200 WATT - Forward Throw

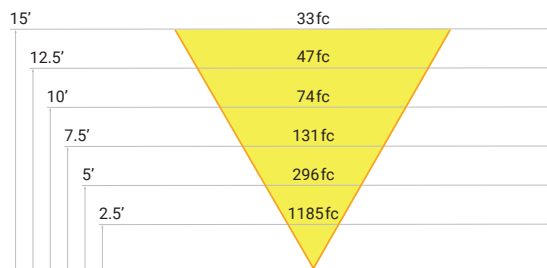

200 WATT - Wide Forward Throw

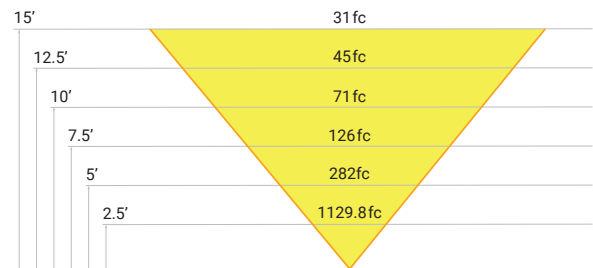

270 WATT - Forward Throw

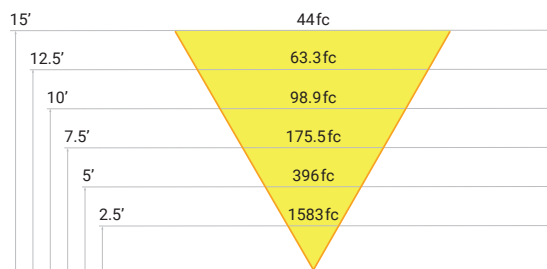

270 WATT - Wide Forward Throw

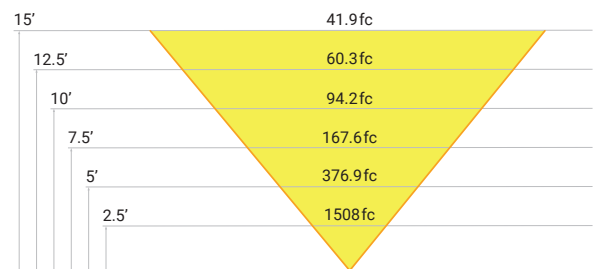

340 WATT - Forward Throw

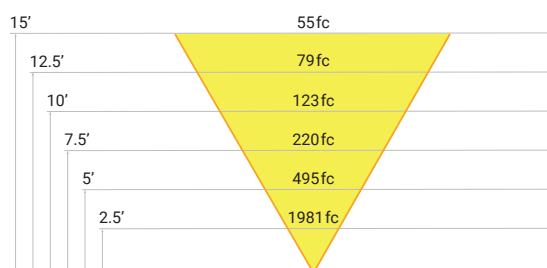

340 WATT - Wide Forward Throw

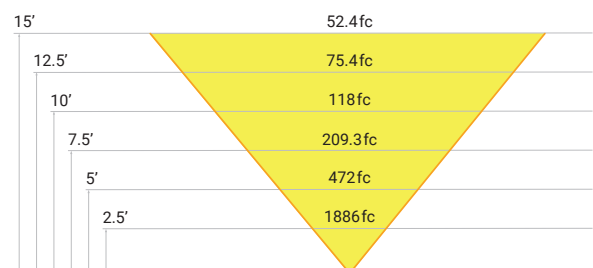

ADJUSTABLE LENS ANGLE

Illustration showing 24" Butterfly Truss (x4) Lenses.

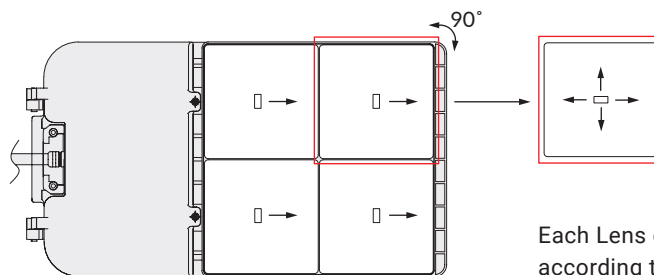

Each Lens can be rotated 90°. You can adjust angle according to your requirement.

DIMENSIONS

Main illustration showing
16" Butterfly Truss
(x2) Lenses.

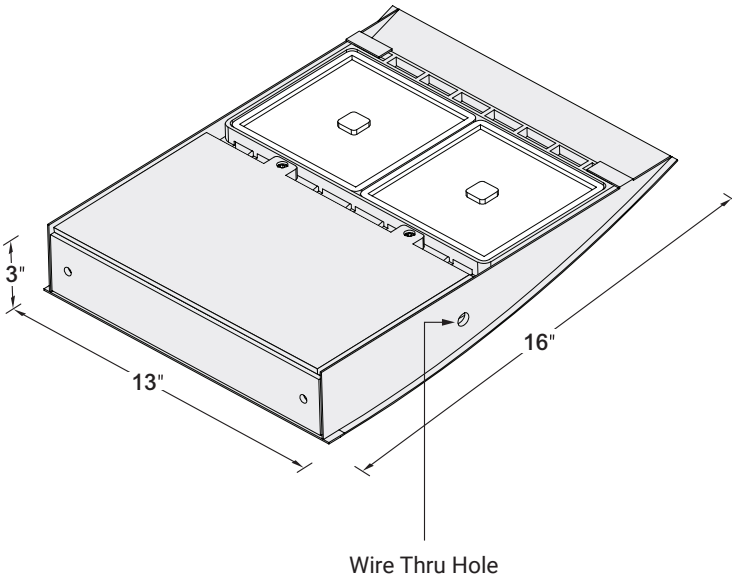

ISOMETRIC VIEW

Isometric View
illustration showing
24" Butterfly Truss
(x4) Lenses.

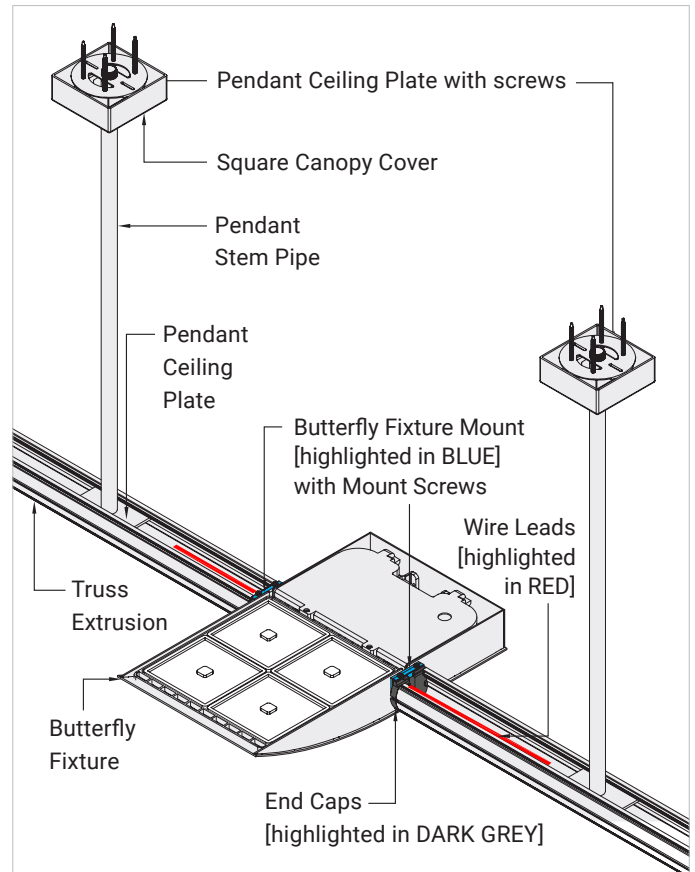

ACCESSORIES

W Wide Optic
Wide Forward Throw Lens

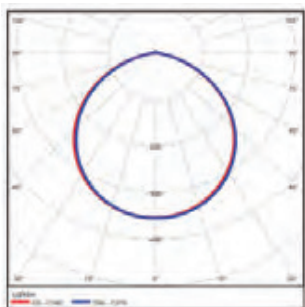

ADD-ONS

Surge Protection



Part # 3650LEDSP10KU
10KV 120-277V
(Surge Protection)



Part # 3650LEDSP20KU
20KV 120-277V
(Surge Protection)

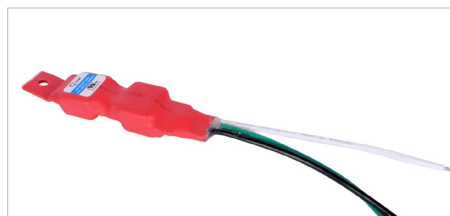

Part # 3650LEDSP20KU2
20KV 347-480V
(Surge Protection)

ELECTRICAL DETAILS

NON-DIMMING 3 Wire 120-277V

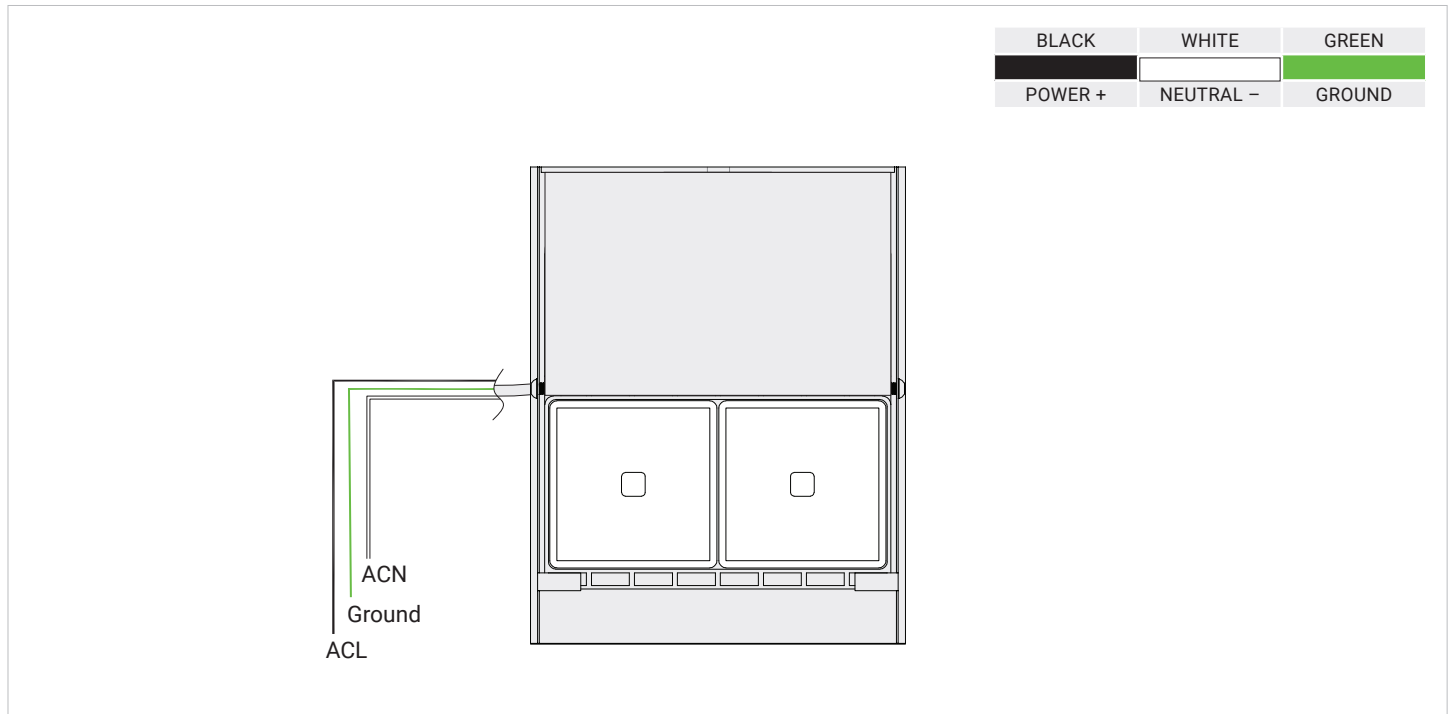

0-10V DIMMING 5 Wire 120-277V

